

*ES*  
**Skena**  
LA SILLA SALUDABLE



**DILE**

Skena es la nueva **silla operativa saludable**. Su respaldo malla y el **soporte lumbar** diseñado para que se regule de manera **independiente**, favorece la adaptación asimétrica a cada usuario. Su forma orgánica y curva pronunciada anticipa a simple vista su comodidad y ergonomía.



*Skena* • Saludable



*Skena* • Beneficiosa

*Designed by  
Emmanuel Zonta*

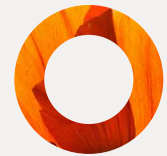

*Skena* • Customizable



*Skena* • Completa

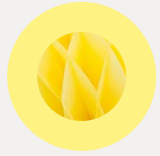

# *ES* **SALUDABLE**

Los seres humanos no estamos diseñados para estar sentados tantas horas pero nuestro estilo de vida ha cambiado. Es por ello que una postura correcta resulta necesaria para mantenerse sano y ser eficaz en el trabajo.



*Skena* • Saludable

*Skena* • Beneficiosa

*Skena* • Customizable

*Skena* • Completa



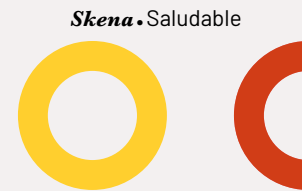
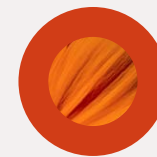

**Skena** • Saludable



Gracias al diseño de Skena se podrá conseguir una buena higiene postural .

**Skena** • Beneficiosa



**Skena** • Customizable

**Skena** • Completa



# *ES* **BENEFICIOSA**

El soporte lumbar independiente asegura una curvatura óptima de la columna al estar sentado. Alivia y previene el dolor lumbar originado por los malos hábitos.



Skena • Beneficiosa

Skena • Customizable

Skena • Completa

**Skena** • Saludable



Skena dispone la opción de ampliar sus magnificas prestaciones con la incorporación de perchero y cabecero regulable.

**Skena** • Beneficiosa

**Skena** • Customizable



**Skena** • Completa

*ES*

**CUSTOMIZABLE**

Diseña tu silla según tu personalidad y modo de vida.

Colorea el respaldo con la carta de colores RAL y combínalo con el tejido que más te guste.

*ES*  
**AMARILLA**



*ES*  
**NARANJA**



*ES*  
**VERDE**



Skena • Beneficiosa

Skena • Customizable

*ES*  
**EL COLOR QUE TÚ QUIERAS.**

Skena • Completa



*ES*  
**COMPLETA**



# ES BASE PLANA



## Silla alta malla estructura negra base plana sin brazos | S0000-12bb-xyyy

Referencia	Base	Respaldo malla	Ruedas	Mecanismo
S3300	plana nylon negro	lumbar regulable asimétrico	nylon/goma	sincro
S3301	plana nylon negro	lumbar regulable asimétrico	nylon/goma	sincro desplazador
S3302	plana aluminio pulido	lumbar regulable asimétrico	romo/goma	sincro
S3303	plana aluminio pulido	lumbar regulable asimétrico	romo/goma	sincro desplazador
S3304	plana aluminio blanco	lumbar regulable asimétrico	romo/goma	sincro
S3305	plana aluminio blanco	lumbar regulable asimétrico	romo/goma	sincro desplazador

Unidades 1 / Peso 20 Kg / Volumen 0,21 m<sup>3</sup>



## Silla alta malla estructura blanca base plana sin brazos | S0000-12bb-xyyy

Referencia	Base	Respaldo malla	Ruedas	Mecanismo
S3310	plana nylon negro	lumbar regulable asimétrico	nylon/goma	sincro
S3311	plana nylon negro	lumbar regulable asimétrico	nylon/goma	sincro desplazador
S3312	plana aluminio pulido	lumbar regulable asimétrico	romo/goma	sincro
S3313	plana aluminio pulido	lumbar regulable asimétrico	romo/goma	sincro desplazador
S3314	plana aluminio blanco	lumbar regulable asimétrico	romo/goma	sincro
S3315	plana aluminio blanco	lumbar regulable asimétrico	romo/goma	sincro desplazador

Unidades 1 / Peso 20 Kg / Volumen 0,21 m<sup>3</sup>

**Skena** • Saludable

**Skena** • Beneficiosa

**Skena** • Customizable

**Skena** • Completa

# ES BASE CÓNICA

Skena • Saludable



## Silla alta malla estructura negra base cónica sin brazos | S0000-12bb-xyy

Referencia	Base	Respaldo malla	Ruedas	Mecanismo
S3320	conica nylon negro	lumbar regulable asimétrico	nylon/goma	sincro
S3321	conica nylon negro	lumbar regulable asimétrico	nylon/goma	sincro desplazador
S3322	conica aluminio pulido	lumbar regulable asimétrico	romo/goma	sincro
S3323	conica aluminio pulido	lumbar regulable asimétrico	romo/goma	sincro desplazador
S3324	conica aluminio blanco	lumbar regulable asimétrico	romo/goma	sincro
S3325	conica aluminio blanco	lumbar regulable asimétrico	romo/goma	sincro desplazador

Unidades 1 / Peso 20 Kg / Volumen 0,21 m<sup>3</sup>

Skena • Beneficiosa



## Silla alta malla estructura blanca base cónica sin brazos | S0000-12bb-xyy

Referencia	Base	Respaldo malla	Ruedas	Mecanismo
S3330	conica nylon negro	lumbar regulable asimétrico	nylon/goma	sincro
S3331	conica nylon negro	lumbar regulable asimétrico	nylon/goma	sincro desplazador
S3332	conica aluminio pulido	lumbar regulable asimétrico	romo/goma	sincro
S3333	conica aluminio pulido	lumbar regulable asimétrico	romo/goma	sincro desplazador
S3334	conica aluminio blanco	lumbar regulable asimétrico	romo/goma	sincro
S3335	conica aluminio blanco	lumbar regulable asimétrico	romo/goma	sincro desplazador

Unidades 1 / Peso 20 Kg / Volumen 0,21 m<sup>3</sup>

Skena • Customizable

Skena • Completa



**Brazos opcionales**

Referencia	Características
A004	Entrega silla semimontada
A006	Entrega silla montada

Referencia	BR02	BR23	BR26	BR03	BR04
Características	1D	1D	2D	3D	4D



**¡MUY IMPORTANTE!**

La silla lleva como rueda por defecto la referencia S9103 para las bases nylon y la referencia S9104 para las bases aluminio.

**Ruedas**

Referencia	S9106	S9107	S9104	S9103
Características	Ruedas huecas Emilsider gris 65mm (24H)	Ruedas huecas negras 65mm	Ruedas cromo/goma 65mm	Ruedas nylon/goma 65mm
bases nylon	✓	✓	✓	✓
bases aluminio	✓	✓	✓	✓

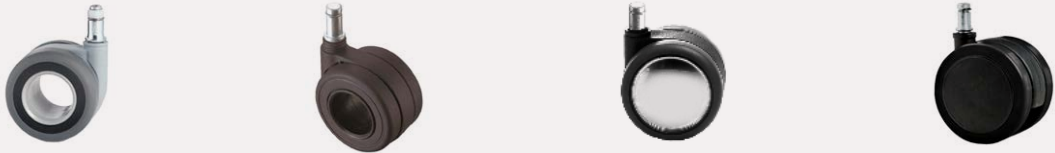

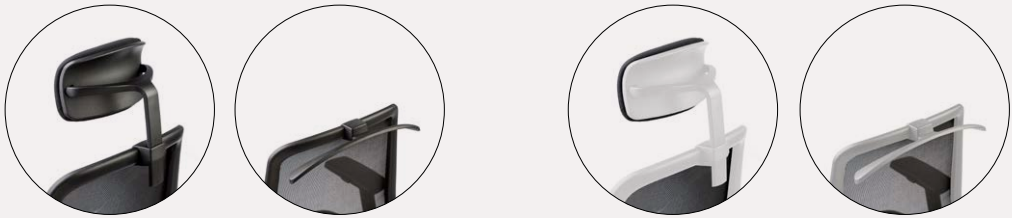

Accesorios

Referencia	Características
S3340	Cabecero tapizado regulable en altura y profundidad negro
S3350	Cabecero tapizado regulable en altura y profundidad blanco
K0700	Perchero negro
K0701	Perchero blanco

Skena • Beneficiosa

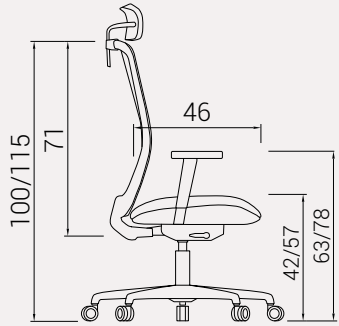
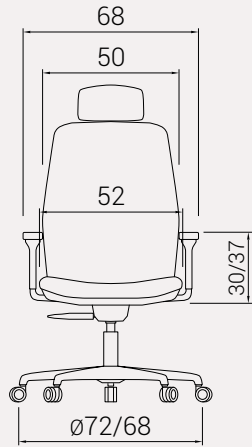

color respaldo malla (xx)	
01	blanco
02	negro
06	naranja
20	verde
22	gris
26	marrón
27	azul

Skena • Customizable



Skena • Completa



dileoffice.com

